

Net Metering Service



Customer Information Package



An **AEP** Company

Net Metering - The means of measuring the difference between the electricity supplied by an electric utility and the electricity generated from an alternative or renewable energy resource facility owned or operated by an electric retail customer when any portion of the electricity generated by the alternative energy resource facility is used to offset part or all of the electric retail customer requirements for electricity.

This package is intended to provide documents for commonly installed inverter-based photovoltaic and/or wind turbine generating systems less than or equal to 30 kW that may qualify for Net Metering Service – Level 1. Documents for larger or non-inverter based systems may be requested from Jacob H. Crocker (jhcrocker@aep.com) at 614-716-2183.

The enclosed “Tariff Net Metering Service” provides detailed information regarding availability of the service, charges, metering, conditions of service, and technical requirements.

Company approval of connecting a generator to its distribution system is required.

Summary of the process:

1. A completed Interconnection Application is submitted to the Company (includes:
1. inverter certification document 2. site diagram and 3. electrical one line diagram)
2. Company reviews application.
3. Company will notify customer of approval or disapproval of interconnection and provide any applicable conditions. Approval is subject to Customer’s compliance to all the Terms and Conditions included in the “Application for Interconnection and Net Metering”
4. The Customer installs an external alternating current (AC) disconnect switch adjacent to the Company meter, readily accessible to the Company, and lockable. This disconnect is labeled as “Generator AC Disconnect Switch”.
5. Under net metering, a single meter is used to register the net energy flow in and out of the structure. The Company will verify the ability of the meter for reverse measurement.
6. Following the completion of all steps above, the Customer may connect generator to the Kentucky Power distribution system.

(Note: Some documents within are dated and subject to change. It may be necessary to contact the Company for the latest documents.)

Index

Tariff Net Metering Service

Application Check List

Application for Interconnection and net metering - Level 1

TARIFF N.M.S.
(Net Metering Service)

AVAILABILITY OF SERVICE.

Net Metering is available to eligible customer-generators in the Company’s service territory, upon request, and on a first-come, first-served basis up to a cumulative capacity of one percent (1%) of the Company’s single hour peak load in Kentucky during the previous year. If the cumulative generating capacity of net metering systems reaches 1% of the Company’s single hour peak load during the previous year, upon Commission approval, the Company’s obligation to offer net metering to a new customer-generator may be limited. An eligible customer-generator shall mean a retail electric customer of the Company with a generating facility that:

- (1) Generates electricity using solar energy, wind energy, biomass or biogas energy, or hydro energy;
- (2) Has a rated capacity of not greater than thirty (30) kilowatts;
- (3) Is located on the customer’s premises;
- (4) Is owned and operated by the customer;
- (5) Is connected in parallel with the Company’s electric distribution system; and
- (6) Has the primary purpose of supplying all or part of the customer’s own electricity requirements.

At its sole discretion, the Company may provide Net Metering to other customer-generators not meeting all the conditions listed above on a case-by-case basis.

The term “Customer” hereinafter shall refer to any customer requesting or receiving Net Metering services under this tariff.

METERING.

Net energy metering shall be accomplished using a standard kilowatt-hour meter capable of measuring the flow of electricity in two (2) directions. If the existing electrical meter installed at the customer’s facility is not capable of measuring the flow of electricity in two directions, the Company will provide the customer with the appropriate metering at no additional cost to the customer. If the customer requests any additional meter or meters or if distribution upgrades are needed to monitor the flow in each direction, such installations shall be at the customer’s expense.

BILLING/MONTHLY CHARGES.

Monthly charges for energy, and demand where applicable, to serve the customer’s net or total load shall be determined according to the Company’s standard service tariff under which the customer would otherwise be served, absent the customer’s electric generating facility. Energy charges under the customer’s standard tariff shall be applied to the customer’s net energy for the billing period to the extent that the net energy exceeds zero. If the customer’s net energy is zero or negative during the billing period, the customer shall pay only the non-energy charge portions of the standard tariff bill. If the customer’s net energy is negative during a billing period, the customer shall be credited in the next billing period for the kWh difference. If time-of-day metering is used, energy flows in both directions shall be netted and accounted for at the specific time-of-use in accordance with the provisions of the customer’s standard tariff and this Net Metering Service Tariff. When the customer elects to no longer take service under this Net Metering Service Tariff, any unused credit shall revert to the Company. Excess electricity credits are not transferable between customers or locations.

(Cont’d on Sheet No. 27-2)

DATE OF ISSUE: February 7, 2018

DATE EFFECTIVE: Service Rendered On And After January 19, 2018

ISSUED BY: /s/ Ranie K. Wohnhas

TITLE: Managing Director, Regulatory & Finance

By Authority Of an Order of the Public Service Commission

In Case No. 2017-00179 Dated January 18, 2018

KENTUCKY PUBLIC SERVICE COMMISSION
Gwen R. Pinson Executive Director

EFFECTIVE 1/19/2018 PURSUANT TO 807 KAR 5:011 SECTION 9 (1)

TARIFF N.M.S. (Cont'd)
(Net Metering Service)

APPLICATION AND APPROVAL PROCESS.

The Customer shall submit an Application for Interconnection and Net Metering ("Application") and receive approval from the Company prior to connecting the generator facility to the Company's system.

Applications will be submitted by the Customer and reviewed and processed by the Company according to either Level 1 or Level 2 processes defined below.

The Company may reject an Application for violations of any code, standard, or regulation related to reliability or safety; however, the Company will work with the Customer to resolve those issues to the extent practicable.

Customers may contact the Company to check on the status of an Application or with questions prior to submitting an Application. Company contact information can be found on Kentucky Power Company's Application Form or on the Company's website.

LEVEL 1 AND LEVEL 2 DEFINITIONS.

LEVEL 1

A Level 1 Application shall be used if the generating facility is inverter-based and is certified by a nationally recognized testing laboratory to meet the requirements of Underwriters Laboratories Standard 1741 "Inverters, Converters, Controllers and Interconnection System Equipment for Use With Distributed Energy Resources" (UL 1741).

The Company will approve the Level 1 Application if the generating facility also meets all of the following conditions:

- (1) For interconnection to a radial distribution circuit, the aggregated generation on the circuit, including the proposed generating facility, will not exceed 15% of the Line Section's most recent annual one hour peak load. A line section is the smallest part of the primary distribution system the generating facility could remain connected to after operation of any sectionalizing devices.
- (2) If the proposed generating facility is to be interconnected on a single-phase shared secondary, the aggregate generation capacity on the shared secondary, including the proposed generating facility, will not exceed the smaller of 20 kVA or the nameplate rating of the transformer.
- (3) If the proposed generating facility is single-phase and is to be interconnected on a center tap neutral of a 240 volt service, its addition shall not create an imbalance between the two sides of the 240 volt service of more than 20% of the nameplate rating of the service transformer.
- (4) If the generating facility is to be connected to three-phase, three wire primary Company distribution lines, the generator shall appear as a phase-to-phase connection at the primary Company distribution line.
- (5) If the generating facility is to be connected to three-phase, four wire primary Company distribution lines, the generator shall appear to the primary Company distribution line as an effectively grounded source.
- (6) The interconnection will not be on an area or spot network.
- (7) The Company does not identify any violations of any applicable provisions of IEEE 1547, "Standard for Interconnecting Distributed Resources with Electric Power Systems."
- (8) No construction of facilities by the Company on its own system will be required to accommodate the generating facility.

(Cont'd on Sheet No. 27-3)

DATE OF ISSUE: February 7, 2018

DATE EFFECTIVE: Service Rendered On And After January 19, 2018

ISSUED BY: /s/ Ranie K. Wohnhas

TITLE: Managing Director, Regulatory & Finance

By Authority Of an Order of the Public Service Commission

In Case No. 2017-00179 Dated January 18, 2018

KENTUCKY PUBLIC SERVICE COMMISSION
Gwen R. Pinson Executive Director

EFFECTIVE 1/19/2018 PURSUANT TO 807 KAR 5:011 SECTION 9 (1)

TARIFF N.M.S. (Cont'd)
(Net Metering Service)

LEVEL 1, continued

If the generating facility does not meet all of the above listed criteria, the Company, in its sole discretion, may either: 1) approve the generating facility under the Level 1 Application if the Company determines that the generating facility can be safely and reliably connected to the Company's system; or 2) deny the Application as submitted under the Level 1 Application.

The Company shall notify the customer within 20 business days whether the Application is approved or denied, based on the criteria provided in this section.

If the Application lacks complete information, the Company shall notify the customer that additional information is required, including a list of such additional information. The time between notification and receipt of required additional information will add to the time to process the Application.

When approved, the Company will indicate by signing the approval line on the Level 1 Application Form and returning it to the customer. The approval will be subject to successful completion of an initial installation inspection and witness test if required by the Company. The Company's approval section of the Application will indicate if an inspection and witness test are required. If so, the customer shall notify the Company within 3 business days of completion of the generating facility installation and schedule an inspection and witness test with the Company to occur within 10 business days of completion of the generator facility installation or as otherwise agreed to by the Company and the customer. The customer may not operate the generating facility until successful completion of such inspection and witness test, unless the Company expressly permits operational testing not to exceed two hours. If the installation fails the inspection or witness test due to noncompliance with any provision in the Application and Company approval, the customer shall not operate the generating facility until any and all noncompliance is corrected and re-inspected by the Company.

If the Application is denied, the Company will supply the customer with reasons for denial. The customer may resubmit under Level 2 if appropriate.

LEVEL 2

A Level 2 Application is required under any of the following:

- (1) The generating facility is not inverter based;
- (2) The generating facility uses equipment that is not certified by a nationally recognized testing laboratory to meet the requirements of UL 1741; or
- (3) The generating facility does not meet one or more of the additional conditions under Level 1.

The Company will approve the Level 2 Application if the generating facility meets the Company's technical interconnection requirements, which are based on IEEE 1547. The Company shall make its technical interconnection requirements available online and upon request.

(Cont'd on Sheet No. 27-4)

DATE OF ISSUE: February 7, 2018

DATE EFFECTIVE: Service Rendered On And After January 19, 2018

ISSUED BY: /s/ Ranie K. Wohnhas

TITLE: Managing Director, Regulatory & Finance

By Authority Of an Order of the Public Service Commission

In Case No. 2017-00179 Dated January 18, 2018

KENTUCKY PUBLIC SERVICE COMMISSION
Gwen R. Pinson Executive Director

EFFECTIVE 1/19/2018 PURSUANT TO 807 KAR 5:011 SECTION 9 (1)

TARIFF N.M.S. (Cont'd)
(Net Metering Service)**LEVEL 2, continued**

The Company will process the Level 2 Application within 30 business days of receipt of a complete Application. Within that time the Company will respond in one of the following ways:

- (1) The Application is approved and the Company will provide the customer with an Interconnection Agreement to sign.
- (2) If construction or other changes to the Company's distribution system are required, the cost will be the responsibility of the customer. The Company will give notice to the customer and offer to meet to discuss estimated costs and construction timeframe. Should the customer agree to pay for costs and proceed, the Company will provide the customer with an Interconnection Agreement to sign within a reasonable time.
- (3) The Application is denied. The Company will supply the customer with reasons for denial and offer to meet to discuss possible changes that would result in Company approval. Customer may resubmit Application with changes.

If the Application lacks complete information, the Company shall notify the customer that additional information is required, including a list of such additional information. The time between notification and receipt of required additional information will add to the 30-business-day target to process the Application.

The Interconnection Agreement will contain all the terms and conditions for interconnection consistent with those specified in this tariff, inspection and witness test requirements, description of and cost of construction or other changes to the Company's distribution system required to accommodate the generating facility, and detailed documentation of the generating facilities which may include single line diagrams, relay settings, and a description of operation.

The customer may not operate the generating facility until an Interconnection Agreement is signed by the customer and Company and all necessary conditions stipulated in the agreement are met.

APPLICATION, INSPECTION AND PROCESSING FEES.

No application fee or other review, study, or inspection or witness test fees will be charged by the company for Level I application.

The Company will require each customer to submit with each Level 2 Application a non-refundable application, inspection and processing fee of \$50. In the event the Company determines an impact study is necessary with respect to a Level 2 Application, the customer shall be responsible for any reasonable costs up to \$1,000 for the initial impact study. The Company shall provide documentation of the actual cost of the impact study. Any other studies requested by the customer shall be at the customer's sole expense.

(Cont'd on Sheet No. 27-5)

DATE OF ISSUE: February 7, 2018

DATE EFFECTIVE: Service Rendered On And After January 19, 2018

ISSUED BY: /s/ Ranie K. Wohnhas

TITLE: Managing Director, Regulatory & Finance

By Authority Of an Order of the Public Service Commission

In Case No. 2017-00179 Dated January 18, 2018

**KENTUCKY
PUBLIC SERVICE COMMISSION**

Gwen R. Pinson
Executive Director



EFFECTIVE

1/19/2018

PURSUANT TO 807 KAR 5:011 SECTION 9 (1)

TARIFF N.M.S. (Cont'd)
(Net Metering Service)

TERMS AND CONDITIONS FOR INTERCONNECTION.

To interconnect to the Company's distribution system, the customer's generating facility shall comply with the following terms and conditions:

- (1) The Company shall provide the customer net metering services, without charge for standard metering equipment, through a standard kilowatt-hour metering system capable of measuring the flow of electricity in two (2) directions. If the customer requests any additional meter or meters or distribution upgrades are needed to monitor the flow in each direction, such installations shall be at the customer's expense.
- (2) The customer shall install, operate, and maintain, at customer's sole cost and expense, any control, protective, or other equipment on the customer's system required by the Company's technical interconnection requirements based on IEEE 1547, the NEC, accredited testing laboratories such as Underwriters Laboratories, and the manufacturer's suggested practices for safe, efficient and reliable operation of the generating facility in parallel with Company's electric system. Customer shall bear full responsibility for the installation, maintenance and safe operation of the generating facility. Upon reasonable request from the Company, the customer shall demonstrate generating facility compliance.
- (3) The generating facility shall comply with, and the customer shall represent and warrant its compliance with: (a) any applicable safety and power quality standards established by IEEE and accredited testing laboratories such as Underwriters Laboratories; (b) the NEC as may be revised from time to time; (c) Company's rules, regulations, and Company's Terms and Conditions of Service as contained in Company's Retail Electric Tariff as may be revised from time to time with the approval of the Kentucky Public Service Commission (Commission); (d) the rules and regulations of the Commission, as such rules and regulations may be revised from time to time by the Commission; and (e) all other applicable local, state, and federal codes and laws, as the same may be in effect from time to time. Where required by law, customer shall pass an electrical inspection of the generating facility by a local authority having jurisdiction over the installation.
- (4) Any changes or additions to the Company's system required to accommodate the generating facility shall be considered excess facilities. Customer shall agree to pay Company for actual costs incurred for all such excess facilities prior to construction.
- (5) Customer shall operate the generating facility in such a manner as not to cause undue fluctuations in voltage, intermittent load characteristics or otherwise interfere with the operation of Company's electric system. At all times when the generating facility is being operated in parallel with Company's electric system, customer shall so operate the generating facility in such a manner that no adverse impacts will be produced thereby to the service quality rendered by Company to any of its other customers or to any electric system interconnected with Company's electric system. Customer shall agree that the interconnection and operation of the generating facility is secondary to, and shall not interfere with, Company's ability to meet its primary responsibility of furnishing reasonably adequate service to its customers.

(Cont'd on Sheet No. 27-6)

DATE OF ISSUE: February 7, 2018

DATE EFFECTIVE: Service Rendered On And After January 19, 2018

ISSUED BY: /s/ Ranie K. Wohnhas

TITLE: Managing Director, Regulatory & Finance

By Authority Of an Order of the Public Service Commission

In Case No. 2017-00179 Dated January 18, 2018

KENTUCKY PUBLIC SERVICE COMMISSION
Gwen R. Pinson Executive Director

EFFECTIVE 1/19/2018
PURSUANT TO 807 KAR 5:011 SECTION 9 (1)

**TARIFF N.M.S.
(Net Metering Service)**

TERMS AND CONDITIONS FOR INTERCONNECTION, continued

- (6) Customer shall be responsible for protecting, at customer’s sole cost and expense, the generating facility from any condition or disturbance on Company’s electric system, including, but not limited to, voltage sags or swells, system faults, outages, loss of a single phase of supply, equipment failures, and lightning or switching surges, except that the Company shall be responsible for repair of damage caused to the generating facility resulting solely from the negligence or willful misconduct on the part of the Company.
- (7) After initial installation, Company shall have the right to inspect and/or witness commissioning tests, as specified in the Level 1 or Level 2 Application and approval process. Following the initial testing and inspection of the generating facility and upon reasonable advance notice to customer, Company shall have access at reasonable times to the generating facility to perform reasonable on-site inspections to verify that the installation, maintenance, and operation of the generating facility comply with the requirements of this tariff.
- (8) For Level 1 and 2 generating facilities, where required by the Company, an eligible customer shall furnish and install on customer’s side of the point of common coupling a safety disconnect switch which shall be capable of fully disconnecting the customer’s energy generating equipment from Company’s electric service under the full rated conditions of the customer’s generating facility. The external disconnect switch (EDS) shall be located adjacent to Company’s meters or the location of the EDS shall be noted by placing a sticker on the meter, and shall be of the visible break type in a metal enclosure which can be secured by a padlock. If the EDS is not located directly adjacent to the meter, the customer shall be responsible for ensuring that the location of the EDS is properly and legibly identified for so long as the generating facility is operational. The disconnect switch shall be accessible to Company personnel at all times. The Company may waive the requirement for an EDS for a generating facility at its sole discretion, and on a case-by-case basis, upon review of the generating facility operating parameters and if permitted under the Company’s safety and operating protocols.

The Company shall establish a training protocol for line workers on the location and use of the EDS, and shall require that the EDS be used when appropriate, and that the switch be turned back on once the disconnection is no longer necessary.

- (9) Company shall have the right and authority at Company’s sole discretion to isolate the generating facility or require the customer to discontinue operation of the generating facility if Company believes that: (a) continued interconnection and parallel operation of the generating facility with Company’s electric system creates or contributes (or may create or contribute) to a system emergency on either Company’s or customer’s electric system; (b) the generating facility is not in compliance with the requirements of this tariff, and the noncompliance adversely affects the safety, reliability, or power quality of Company’s electric system; or (c) the generating facility interferes with the operation of Company’s electric system. In non-emergency situations, Company shall give customer notice of noncompliance including a description of the specific noncompliance condition and allow customer a reasonable time to cure the noncompliance prior to isolating the generating facilities. In emergency situations, when the Company is unable to immediately isolate or cause the customer to isolate only the generating facility, the Company may isolate the customer’s entire facility.

(Cont’d on Sheet No. 27-7)

DATE OF ISSUE: February 7, 2018

DATE EFFECTIVE: Service Rendered On And After January 19, 2018

ISSUED BY: /s/ Ranie K. Wohnhas

TITLE: Managing Director, Regulatory & Finance

By Authority Of an Order of the Public Service Commission

In Case No. 2017-00179 Dated January 18, 2018

KENTUCKY PUBLIC SERVICE COMMISSION
Gwen R. Pinson Executive Director

EFFECTIVE 1/19/2018 PURSUANT TO 807 KAR 5:011 SECTION 9 (1)

**TARIFF N.M.S.
(Net Metering Service)**

TERMS AND CONDITIONS FOR INTERCONNECTION, continued

- (10) Customer shall agree that, without the prior written permission from Company, no changes shall be made to the generating facility as initially approved. Increases in generating facility capacity will require a new "Application for Interconnection and Net Metering" which will be evaluated on the same basis as any other new application. Repair and replacement of existing generating facility components with like components that meet UL 1741 certification requirements for Level 1 facilities and not resulting in increases in generating facility capacity is allowed without approval.
- (11) To the extent permitted by law, the customer shall protect, indemnify, and hold harmless the Company and its directors, officers, employees, agents, representatives and contractors against and from all loss, claims, actions or suits, including costs and attorneys fees, for or on account of any injury or death of persons or damage to property caused by the customer or the customer's employees, agents, representatives and contractors in tampering with, repairing, maintaining, or operating the customer's generating facility or any related equipment or any facilities owned by the Company except where such injury, death or damage was caused or contributed to by the fault or negligence of the Company or its employees, agents, representatives, or contractors.

The liability of the Company to the customer for injury to person and property shall be governed by the tariff(s) for the class of service under which the customer is taking service.
- (12) The customer shall maintain general liability insurance coverage (through a standard homeowner's, commercial, or other policy) for both Level 1 and Level 2 generating facilities. Customer shall, upon request, provide Company with proof of such insurance at the time that application is made for net metering.
- (13) By entering into an Interconnection Agreement, or by inspection, if any, or by non-rejection, or by approval, or in any other way, Company does not give any warranty, express or implied, as to the adequacy, safety, compliance with applicable codes or requirements, or as to any other characteristics, of the generating facility equipment, controls, and protective relays and equipment.
- (14) A customer's generating facility is transferable to other persons or service locations only after notification to the Company has been made and verification that the installation is in compliance with this tariff. Upon written notification that an approved generating facility is being transferred to another person, customer, or location, the Company will verify that the installation is in compliance with this tariff and provide written notification to the customer(s) within 20 business days. If the installation is no longer in compliance with this tariff, the Company will notify the customer in writing and list what must be done to place the facility in compliance.
- (15) The customer shall retain any and all Renewable Energy Credits (RECs) that may be generated by their generating facility.

(Cont'd on Sheet No. 27-8)

DATE OF ISSUE: February 7, 2018

DATE EFFECTIVE: Service Rendered On And After January 19, 2018

ISSUED BY: /s/ Ranie K. Wohnhas

TITLE: Managing Director, Regulatory & Finance

By Authority Of an Order of the Public Service Commission

In Case No. 2017-00179 Dated January 18, 2018

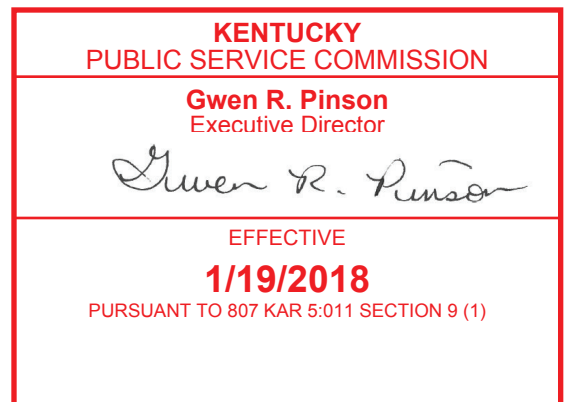

**TARIFF N.M.S.
(Net Metering Service)**

TERM OF CONTRACT.

Any contract required under this tariff shall become effective when executed by both parties and shall continue in effect until terminated. The contract may be terminated as follows: (a) Customer may terminate the contract at any time by giving the Company at least sixty (60) days' written notice; (b) Company may terminate upon failure by the customer to continue ongoing operation of the generating facility; (c) either party may terminate by giving the other party at least thirty (30) days prior written notice that the other party is in default of any of the terms and conditions of the contract or the rules or any rate schedule, tariff, regulation, contract, or policy of the Company, so long as the notice specifies the basis for termination and there is opportunity to cure the default; (d) the Company may terminate by giving the customer at least thirty (30) days notice in the event that there is a material change in an applicable law, regulation or statute affecting this Agreement or which renders the system out of compliance with the new law or statute.

SPECIAL TERMS AND CONDITIONS.

This tariff is subject to the Company's Terms and Conditions of Service and all provisions of the standard service tariff under which the customer takes service. This tariff is also subject to the applicable provisions of the Company's Technical Requirements for Interconnection.

(Cont'd on Sheet No. 27-9)

DATE OF ISSUE: February 7, 2018

DATE EFFECTIVE: Service Rendered On And After January 19, 2018

ISSUED BY: /s/ Ranie K. Wohnhas

TITLE: Managing Director, Regulatory & Finance

By Authority Of an Order of the Public Service Commission

In Case No. 2017-00179 Dated January 18, 2018

KENTUCKY PUBLIC SERVICE COMMISSION
Gwen R. Pinson Executive Director 
EFFECTIVE 1/19/2018 PURSUANT TO 807 KAR 5:011 SECTION 9 (1)

Application Checklist

- Obtained permits
- Secured liability insurance
- Completed application
- Attached Site Diagram showing external AC disconnect switch
- Attached Electrical One-line Diagram
- Provided inverter documentation showing UL 1741 compliance



Application for Interconnection and Net Metering – Level 1

Use this Application only for: 1.) a generating facility that is inverter based and certified by a nationally recognized testing laboratory to meet the requirements of UL 1741, 2.) less than or equal to 30 kW generation capacity and 3.) connecting to Kentucky Power distribution system.

Submit this Application to:

D.G. Coordinator
American Electric Power
1 Riverside Plaza
Columbus, Ohio 43215-2373
614-716-1382 Office / 614-716-1605 Fax
dgcoordinator@aep.com

(Contact person listed is subject to change. Please visit our website for up-to-date information <http://www.kentuckypower.com>)

Applicant

Name: _____

Mailing Address: _____

City: _____ State: _____ Zip: _____

Phone: (____) _____ Phone: (____) _____

E-mail address: _____

Service Location

Name: _____

Street Address: _____

City: _____ State: _____ Zip: _____

Electric Service Account Number: _____

Alternate Contacts

Provide names and contact information for other contractors, installers, or engineering firms involved in the design and installation of the generating facilities:

<u>Name</u>	<u>Company</u>	<u>Telephone/Email</u>
_____	_____	_____
_____	_____	_____
_____	_____	_____

Equipment Qualifications

Energy Source: () Solar () Wind () Hydro () Biogas () Biomass

Inverter Manufacturer: _____ Model: _____

Inverter Power Rating: _____ Voltage Rating: _____

Power Rating of Energy Source (i.e., solar panels, wind turbine): _____

Battery Storage: () Yes () No If Yes, Battery Power Rating: _____

Attach documentation showing that inverter is certified by a nationally recognizes testing laboratory to meet the requirements of UL 1741.

Attach site drawing or sketch showing locations of Kentucky Power Company meter, energy source, accessible disconnect switch and inverter.

Attach single line drawing showing all electrical equipment from the metering location to the energy source including: switches, fuses, breakers, panels, transformers, inverters, energy source, wire size, equipment ratings, and transformer connections.

Expected Start-up Date: _____

Sample Site Diagram

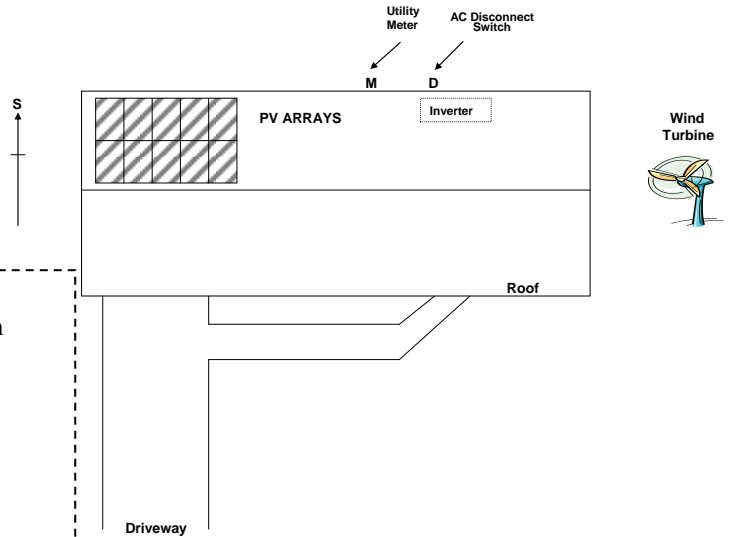

Sample Electrical One-line Diagram

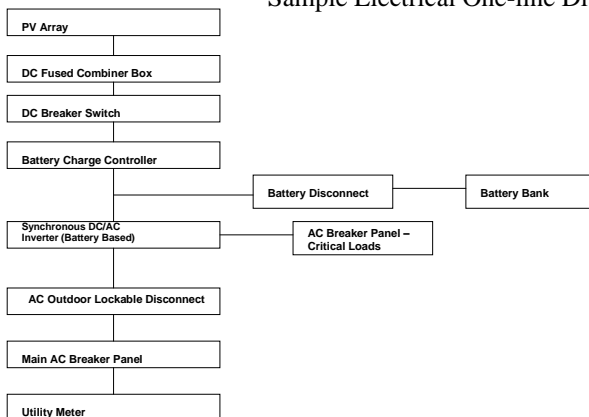

TERMS AND CONDITIONS:

1. Kentucky Power Company (Company) shall provide customer net metering services, without charge for standard metering equipment, through a standard kilowatt-hour metering system capable of measuring the flow of electricity in two (2) directions. If the customer requests any additional meter or meters or distribution upgrades are needed to monitor the flow in each direction, such installations shall be at the customer's expense.
2. Customer shall install, operate, and maintain, at customer's sole cost and expense, any control, protective, or other equipment on the customer's system required by the Company's technical interconnection requirements based on IEEE 1547, the NEC, accredited testing laboratories such as Underwriters Laboratories, and the manufacturer's suggested practices for safe, efficient, and reliable operation of the generating facility in parallel with Company's electric system. Customer shall bear full responsibility for the installation, maintenance, and safe operation of the generating facility. Upon reasonable request from the Company, customer shall demonstrate generating facility compliance.
3. The generating facility shall comply with, and the customer shall represent and warrant its compliance with: (a) any applicable safety and power quality standards established by the Institute of Electrical and Electronics Engineers (IEEE) and accredited testing laboratories such as Underwriters Laboratories (UL); (b) the National Electrical Code (NEC) as may be revised from time to time; (c) Company's rules, regulations, and Company's Terms and Conditions of Service as contained in Company's Retail Electric Tariff as may be revised from time to time with the approval of the Kentucky Public Service Commission (Commission); (d) the rules and regulations of the Commission, as such rules and regulations may be revised from time to time by the Commission; and (e) all other applicable local, state, and federal codes and laws, as the same may be in effect from time to time. Where required by law, customer shall pass an electrical inspection of the generating facility by a local authority having jurisdiction over the installation.
4. Any changes or additions to the Company's system required to accommodate the generating facility shall be considered excess facilities. Customer shall agree to pay Company for actual costs incurred for all such excess facilities prior to construction.
5. Customer shall operate the generating facility in such a manner as not to cause undue fluctuations in voltage, intermittent load characteristics, or otherwise interfere with the operation of Company's electric system. At all times when the generating facility is being operated in parallel with Company's electric system, customer shall so operate the generating facility in such a manner that no adverse impacts will be produced thereby to the service quality rendered by Company to any of its other customers or to any electric system interconnected with Company's electric system. Customer shall agree that the interconnection and operation of the generating facility is secondary to, and shall not interfere with, Company's ability to meet its primary responsibility of furnishing reasonably adequate service to its customers.
6. Customer shall be responsible for protecting, at customer's sole cost and expense, the generating facility from any condition or disturbance on Company's electric system, including, but not limited to, voltage sags or swells, system faults, outages, loss of a single phase of supply, equipment failures, and lightning or switching surges, except that the Company shall be responsible for repair of damage caused to the generating facility resulting solely from the negligence or willful misconduct on the part of the Company.
7. After initial installation, Company shall have the right to inspect and/or witness commissioning tests, as specified in the Level 1 or Level 2 Application and approval process. Following the initial testing and inspection of the generating facility and upon reasonable advance notice to customer, Company shall have access at reasonable times to the generating facility to perform reasonable on-site inspections to verify that the installation, maintenance and operation of the generating facility comply with the requirements of this tariff.

8. For Level 1 generating facilities, where required by the Company, an eligible customer shall furnish and install on customer's side of the point of common coupling a safety disconnect switch which shall be capable of fully disconnecting the customer's energy generating equipment from Company's electric service under the full rated conditions of the customer's generating facility. The external disconnect switch (EDS) shall be located adjacent to Company's meters or the location of the EDS shall be noted by placing a sticker on the meter, and shall be of the visible break type in a metal enclosure which can be secured by a padlock. If the EDS is not located directly adjacent to the meter, the customer shall be responsible for ensuring the location of the EDS is properly and legibly identified for so long as the generating facility is operational. The disconnect switch shall be accessible to Company personnel at all times. The Company may waive the requirement for an EDS for a generating facility at its sole discretion, and on a case-by-case basis, upon review of the generating facility operating parameters and if permitted under the Company's safety and operating protocols.

The Company shall establish a training protocol for line workers on the location and use of the EDS, and shall require that the EDS be used when appropriate, and that the switch be turned back on once the disconnection is no longer necessary.

9. Company shall have the right and authority at Company's sole discretion to isolate the generating facility or require the customer to discontinue operation of the generating facility if Company believes that: (a) continued interconnection and parallel operation of the generating facility with Company's electric system creates or contributes (or may create or contribute) to a system emergency on either Company's or customer's electric system; (b) the generating facility is not in compliance with the requirements of this tariff, and the noncompliance adversely affects the safety, reliability or power quality of Company's electric system; or (c) the generating facility interferes with the operation of Company's electric system. In non-emergency situations, Company shall give customer notice of noncompliance including a description of the specific noncompliance condition and allow customer a reasonable time to cure the noncompliance prior to isolating the generating facilities. In emergency situations, when the Company is unable to immediately isolate or cause the customer to isolate only the generating facility, the Company may isolate the Customer's entire facility.

10. Customer shall agree that, without the prior written permission from Company, no changes shall be made to the generating facility as initially approved. Increases in generating facility capacity will require a new "Application for Interconnection and Net Metering" which will be evaluated on the same basis as any other new application. Repair and replacement of existing generating facility components with like components that meet UL 1741 certification requirements for Level 1 facilities and not resulting in increases in generating facility capacity is allowed without approval.

11. To the extent permitted by law, the customer shall protect, indemnify, and hold harmless the Company and its directors, officers, employees, agents, representatives and contractors against and from all loss, claims, actions or suits, including costs and attorneys fees, for or on account of any injury or death of persons or damage to property caused by the customer or the customer's employees, agents, representatives and contractors in tampering with, repairing, maintaining or operating the Customer's generating facility or any related equipment or any facilities owned by the Company except where such injury, death or damage was caused or contributed to by the fault or negligence of the Company or its employees, agents, representatives, or contractors.

The liability of the Company to the customer for injury to person and property shall be governed by the tariff(s) for the class of service under which the customer is taking service.

12. The customer shall maintain general liability insurance coverage (through a standard homeowner's, commercial, or other policy) for Level 1 generating facilities. Customer shall, upon request, provide Company with proof of such insurance at the time that application is made for net metering.

13. By entering into an Interconnection Agreement, or by inspection, if any, or by non-rejection, or by approval, or in any other way, Company does not give any warranty, express or implied, as to the adequacy, safety, compliance with applicable codes or requirements, or as to any other characteristics, of the generating facility equipment, controls, and protective relays and equipment.

14. Customer's generating facility is transferable to other persons or service locations only after notification to the Company has been made and verification that the installation is in compliance with this tariff. Upon written notification that an approved generating facility is being transferred to another person, customer, or location, the company will verify that the installation is in compliance with this tariff and provide written notification to the Customer(s) within 20 business days. If the installation is no longer in compliance with this tariff, the Company will notify the customer in writing and list what must be done to place the facility in compliance.

15. The Customer shall retain any and all Renewable Energy Credits (RECs) that may be generated by their generating facility.

Effective Term and Termination Rights

This Agreement becomes effective when executed by both parties and shall continue in effect until terminated. This Agreement may be terminated as follows: (a) Customer may terminate this Agreement at any time by giving the Company at least sixty (60) days' written notice; (b) Company may terminate upon failure by the Customer to continue ongoing operation of the generating facility; (c) either party may terminate by giving the other party at least thirty (30) days prior written notice that the other party is in default of any of the terms and conditions of the Agreement or the Rules or any rate schedule, tariff, regulation, contract, or policy of the Company, so long as the notice specifies the basis for termination and there is opportunity to cure the default; (d) the Company may terminate by giving the Customer at least thirty (30) days notice in the event that there is a material change in an applicable law, regulation or statute affecting this Agreement or which renders the system out of compliance with the new law or statute. I hereby certify that, to the best of my knowledge, all of the information provided in this Application is true, and I agree to abide by all the Terms and Conditions included in this Application for Interconnection and Net Metering and Company's Net Metering Tariff.

Customer Signature: _____ **Date:** _____

COMPANY APPROVAL SECTION

When signed below by a Company representative, Application for Interconnection and Net Metering is approved subject to the provisions contained in this Application and as indicated below.

Company inspection and witness test: () Required () Waived

If Company inspection and witness test is required, Customer shall notify the Company within three (3) business days of completion of the generating facility installation and schedule an inspection and witness test with the Company to occur within ten (10) business days of completion of the generating facility installation or as otherwise agreed to by the Company and the Customer. Unless indicated below, the Customer may not operate the generating facility until such inspection and witness test is successfully completed. Additionally, the Customer may not operate the generating facility until all other terms and conditions in the Application have been met.

Call: _____ to schedule an inspection and witness test.

Pre-Inspection operational testing not to exceed two (2) hours: () Allowed () Not Allowed

If Company inspection and witness test is waived, operation of the generating facility may begin when installation is complete, and all other terms and conditions in the Application have been met.

Additions, Changes, or Clarifications to Application Information: () None () As specified here:

Approved by: _____ Date: _____

Printed Name: _____ Title: _____